



evosanitary

STANDARD

**MANUAL DE UTILIZARE / USER'S MANUAL
POMPA DE GRADINA / GARDEN PUMP
JET 105 PLASTIC 800W**



INFORMATII REPARATII IN GARANTIE PE ULTIMA PAGINA



Va multumim pentru achizitionarea acestui produs EVOSANITARY, fabricat conform celor mai inalte standarde de siguranta si de functionare.



Avertizare! Pentru siguranta dumneavoastra cititi cu atentie acest manual si instructiunile generale de siguranta inaintea utilizarii echipamentului. Nerespectarea acestor reguli poate avea ca rezultat producerea electrocutarilor, a incendiilor si/sau a ranirilor personale.

Simboluri

Simbolurile utilizate in manual sau pe produs au urmatoarele semnificatii:

	Atentie!		Produsul este in conformitate cu standardele de siguranta ale Directivelor Europene
	Cititi manualul de utilizare		Izolatie dubla

Masuri de siguranta generale pentru uneltele electrice

Masuri de siguranta a echipamentului in exploatare



ATENTIE! Verificati intotdeauna ca tensiunea de alimentare sa corespunda cu cea inscrisa pe placuta uneltei.

- Nu rasuciti cablul electric de alimentare al echipamentului
- Nu transportati uneltea tinand-o de cablul electric si nu trageți de cablul electric pentru a o scoate din priza.
- Tineti cablul electric de alimentare a masinii la distanta fata de sursele de caldura, de pete de ulei, de grasimi, de obiectele ascutite si sursele care emana caldura.
- Verificati stecherul si cablul electric in mod regulat si in caz de deteriorare a acestora apelati la un electrician autorizat.
- Nu suprasolicitati pompa! Ea poate fi folosita in conditii de siguranta daca sunt respectati parametrii de exploatare care o caracterizeaza. Nu utilizati unelte electrice cu un alt scop fata de cel pentru care sunt destinate.

Service

- Repararea trebuie realizata numai de catre personal autorizat prin inlocuirea cu accesorii si piese de schimb originale pentru a se evita producerea accidentelor datorate reparatiilor necorespunzatoare.

Masuri de siguranta specifice pompei autoamorsante

- Evitati folosirea pompei in conditii de temperaturi mai ridicate de 40°C si mai scazute de 0°C, sau functionarea cu apa la o temperatura mai mare de 35°C.
- Atunci cand pompa este fixata pentru transportul apei dintr-un bazin, o data cu apa sunt absorbite si impuritati, de aceea este recomandata montarea unui filtru.
- Atunci cand pompa este repornita dupa o lunga perioada de pauza, exista posibilitatea ca motorul sa nu functioneze in conditiile unei porniri imediate datorate pastrarii si solidificarii nisipului si a particulelor straine din apa in capul pompei. In acest caz decuplati pompa de la sursa de alimentare cu energie electrica, dupa care rotiti de cateva ori axul din spate al motorului ceea ce va ajuta sa reporniti si sa folositi pompa in exploatare ca de obicei.
- Evitati functionarea pompei in gol.
- Instalarea pompei trebuie efectuata de catre personal calificat.

Domeniu de utilizare.

- Aceasta electropompa este destinata extragerii apei din fantani, bazine, rezervoare, piscine precum si stropirii micilor exploataii agricole sau gradini. Nu utilizati produsul pentru extragerea hidrocarburilor (carburanti, uleiuri, solventi...)
NU ESTE PROIECTATA PENTRU UZ INDUSTRIAL.



ATENȚIE! Pompa este proiectata si construita pentru extragerea apei fara continut de substante explozive , particule solide sau fibre,cu o densitate de 1kg/dmc si o viscozitate cinematica de 1mm² / s sau a lichidelor non-agresive chimic.

Pregatirea pentru punerea in functiune

1. Orificiu admisie apa
2. Orificiu golire
3. Carcasa Inox
4. Cablu alimentare
5. Comutator pornit/oprit
6. Maner transport
7. Orificiu evacuare



ATENȚIE! IN CAZUL IN CARE APAR ZGOMOTE ANORMALE IN FUNCTIONARE OPRIȚI IMEDIAT UNEALTA SI ADRESATI-VA UNUI SERVICE AUTORIZAT PENTRU CONSTATARI SI REPARATII.



ATENȚIE! Dacă există o conducta de aspirație, pot trece cateva minute de la pornirea pompei până ce este livrată apă. Această perioadă depinde de lungimea și diametrul conductei de aspirație.

Verificarea pompei inainte de instalare:

- Instalarea electropompei se face pe o fundatie cimentata pentru stabilitate sporita si exploatare indelungata.
- Instalati un robinet de inchidere cat mai aproape de pompa pentru o interventie facila in cazul lucrarilor de verificare si reparare.

Zona de lucru:

- Inainte de instalarea sorbului in pozitia de lucru asigurati-va ca nu exista nisip sau sedimente solide.In cazul existentei acestora curatati foarte bine amplasamentul sorbului.
- Pompa functioneaza in pozitie orizontala.
- Este foarte important ca nivelul apei sa nu coboare niciodata sub sorbul pompei.
- **PERICOL DE INGHET!** Goliti pompa prin busonul de golire (2) aflat in partea inferioara a pompei in situatia in care ramane inactiva la temperaturi sub 0°C, pentru evitarea deteriorarii ei.

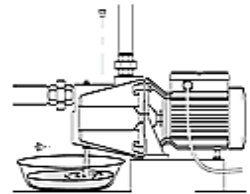

Conexiune hidraulica

- Utilizati tubulatura rigida sau flexibila din metal sau plastic.
- Este recomandata utilizarea unei tubulaturi cu un diametru interior cel putin egal cu cel al pompei, pentru evitarea scaderii performantelor pompei si aparitiei colmatarii.
- Fixati tubulatura astfel incat greutatea acesteia sa nu deterioreze corpul pompei
- Asigurati-va ca adancimea maxima de aspiratie nu depaseste nivelul specificat in datele tehnice ale produsului.

Pe conducta de aspiratie se va monta obligatoriu un sorb cu clapeta de sens in capatul introdus in put, pentru evitarea patrunderii corpurilor straine.

Pe conducta de refulare se vor monta o supapa anti-retur cu inchidere rapida pentru evitarea intoarcerii coloanei de apa si un robinet , in aceasta ordine.

A. Electropompa aspira din vas tampon:

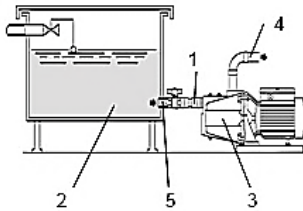

Legenda:

1. Supapa de sens
2. Vas tampon
3. Pompa
4. Conducta refulare 1"
5. Conducta aspiratie 1"

B. Electropompa aspira din put (adancime maxima 8m):

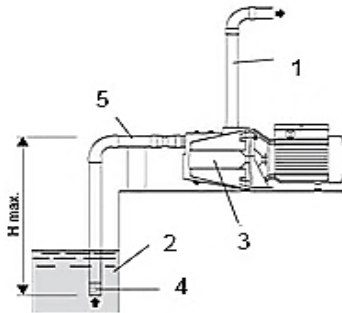

Legenda:

1. Conducta refulare 1"
2. Put
3. Pompa
4. Sorb
5. Conducta aspiratie 1"

Conexiune electrica

- Este recomandata conectarea pompei la un circuit electric cu impamantare dedicat.
- Aceste pompe cu motoare monofazate sunt dotate cu protectie termica si se conecteaza direct la retea prin cablul de alimentare furnizat (4)



ATENTIE! In cazul supraincalzirii motorului pompa se opreste automat. Dupa racire va porni din nou in mod automat, fara a fi necesara nici o interventie.

Pornirea pompei:



ATENTIE! Nu porniți pompa până când nu a fost umplută cu lichid.

- Prin orificiul de evacuare (7) aflat in partea superioara se toarna apa curata in pompa si in conducta de aspiratie pana cand apa curge din electropompa.
- Se monteaza furtunul sau teava de evacuare.
- Se alimenteaza furtunul electric pompa si se apasa pe comutatorul de pornire (5) aflat pe panoul de comanda lateral
- Daca pompa livreaza apa inseamna ca amorsarea a reusit. In caz contrar se reiau operatiunile de amorsare.

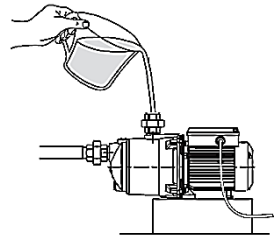

Curatare si intretinere



ATENTIE! Inainte de orice interventie asupra echipamentului, deconectati alimentarea cu energie electrica de la retea.

Curatare

- Pastrati curata zona de ventilatie a carcasei pentru a preveni supraincalzirea motorului si scaderea performantelor pompei
- NU utilizati solventi (ca de exemplu : petrol si derivati, alcool) intrucat acestia pot deteriora partile din plastic.

Intretinere

Echipamentul nostru a fost proiectat astfel incat sa poata fi utilizat pentru o perioada indelungata cu un minimum de intretinere. Nu necesita nici un fel de ungere suplimentara, datorita lubrifiantilor long-life utilizati de producator pentru componentele in miscare.

Caracteristica H (m col H₂O) – Q (l/ min) a pompei JET 105 -800 W

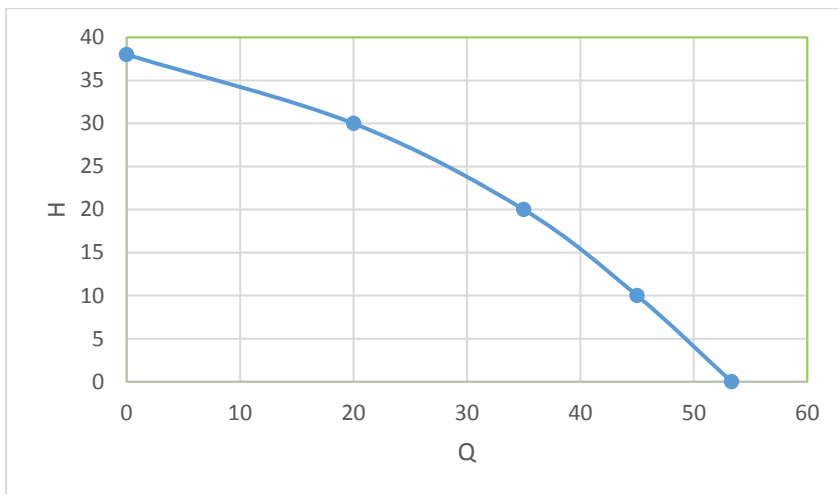

Date tehnice

Putere	800W
Tensiune / Frecventa	230V/50Hz
Debit maxim	53 L/ min
Temperatura maxima lichid pompat	35°C
Adancime maxima de aspiratie	8m
Inaltime maxima de pompare	38m
Racorduri intrare/iesire	1 - 1"
Tip motor	Cu ventilatie fortata
Numar poli	2
Clasa izolatie	F
Grad protectie	IPX4
Ciclu functionare	S1 - continuu
Protectie la suprasarcina	Termica, cu resetare automata

Material corp pompa	Plastic
Etansare pe arbore	Presetupa mecanica
Rulment	Capsulat cu bile
Presiune sonora	LwA=90dB(A)
Greutate	9.2 kg

Asistenta tehnica

Probleme	Cauze	Masuri de remediere
Motorul nu porneste sau se opreste in timpul functionarii	Protectia termica.	Daca motorul este supraincalzit, nu va functiona. Asteptati racirea motorului 20-30 min
	Conexiune electrica incorecta	Verificati conexiunea electrica.
	Cablu electric intrerupt	Inlocuiti cablul electric.
	Defectiuni la motor sau condensator	Contactati reteaua de service HGT
	Tensiune de alimentare scazuta.	Verificati tensiunea sursei de alimentare .
	Rulmenti blocati	Contactati reteaua de service HGT
Pompa functioneaza dar nu livreaza apa sau livreaza o cantitate insuficienta	Pompa dezamorsata	Amorsati pompa
	Adancime de aspiratie prea mare	Corectati adancimea de aspiratie conform specificatiilor tehnice
	Conducta de aspiratie insuficienta imersata	Verificati adancimea de imersie a conductei
	Sorb infundat sau pompa blocata de impuritati	Curatati sorbul sau pompa
	Patrunderea aerului in conducta de aspiratie.	Dupa verificarea imbinarilor, asigurati etansarea perfecta.
	Patrunderea aerului in pompa prin garniturile mecanice.	Inlocuiti garniturile mecanice.
Pompa vibreaza sau produce prea mult zgomot in timpul functionarii	Tevi fixate incorect	Fixati teville
	Rulment uzat	Contactati reteaua de service HGT
	Ventilator motor fixat necorespunzator	Contactati reteaua de service HGT

Depozitare

- Depozitati pompa intr-un spatiu inaccesibil copiilor intr-o pozitie stabila si sigura intr-un loc fara praf sau supus vibratiilor, evitand temperaturile prea ridicate sau scazute.
- Protejati pompa fata de actiunea directa a razelor solare si pastrati-o intr-un loc intunecos, daca este posibil.

Thank you for buying this EVOSANITARY product, manufactured according to the highest safety and performance standards



WARNING! For your own safety, read this manual and the general safety Instructions carefully before using the appliance. Your power tool should only be given to other users together with these instructions.

Symbols

In this manual and/or on the machine the following symbols are used:

	Warning/Danger!		In accordance with essential applicable safety standards of European directives
	Read manual before use		Double insulated

General power tools safety warnings

Electrical safety



Always check that the power supply corresponds to the voltage on the rating plate.

- Do not abuse the cord. Never use the cord for carrying, lifting or operating the pump
- Keep cord away from heat, oil, sharp edges or moving parts. Damaged or entangled cords increase the risk of electric shock.
- Check plug and power cord regularly and in case of damage call to a qualified personnel.
- Do not overload the pump! It can be used safely if operating according to parameters. Do not use power tools for a different purpose than the one for which they are intended.

Service

Your power tool should be serviced by a qualified specialist using only standard spare parts. This will ensure that it meets the required safety standards.

Specific safety instructions for self-priming pump

- Never let pump run dry.
- When installed in wells or tanks the pump, which is particularly silent running, avoid all problems related to suction.
- Installation should be performed by qualified personnel
- Avoid using the pump in conditions of temperatures higher than 40 ° C and lower than 0 ° C or operating with water at a temperature higher than 35 ° C.
- When the pump is fixed to transport water from a pool, with the water are absorbed also impurities, so it is recommended to install a filter.
- When the pump is restarted after a long break, is possible that the engine will not operate immediate after start due to preservation and hardening sand and foreign particles from the water in the pump head. In this case disconnect the power supply, then turn several times the electrical motor spindle which will help to reboot and use the pump in operation as usual.

Application

The pump is intended for lifting water from wells, first collection tanks or cisterns, cellars, garages, swimming pools and for sprinkling systems for small agricultural installations and gardens.

IT IS NOT DESIGNED FOR PROFESSIONAL USE.



This pump is built up for pumping water, free from explosive substances, solid particles and fibers, with a density of 1kg/dmc and a kinematic viscosity of 1mm² / s and chemically non-aggressive liquids.

Assembly

1. Inlet connection
2. Drain hole
3. Stainless steel housing
4. Plug cord
5. ON/OFF switch
6. Handle
7. Outlet connection



WARNING! In case of any abnormal noise, immediately turn off the tool and contact an authorized service facility for repairs



WARNING! If there is a suction pipe, it may take several minutes after start the pump until water is delivered. This period depends on the length and diameter of suction pipe.

Checking of the pump before installation

- The pump must be installed on a concrete foundation for enhanced stability and long service
- Install closing valve closer to the pump for an easy intervention in the case of testing and repair

Site of installation

- Before immersing the pump in the pit or tank, ensure that the place is free from sand and solid sediment. In case there is sediments, clean thoroughly the place.
- Pump is working in horizontally position.
- Keep the sorb above the bottom of pit as to avoid suction of any deposit form after installation.
- It is very important to ensure that water level never falls below the body of pump.
- **DANGER OF FROST! Completely empty** the pump through drain hole (2) when remains inactive at temperature of less than 0°C, to avoid damaging it.

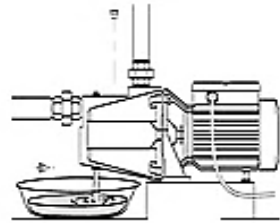

Piping

- The hydraulic connection could be made with iron or plastic parts, either rigid or flexible
- Is recommended to use pipes with an internal diameter at least equal to that of delivery pipe, as to avoid fall in performance and clogging
- The size of pit must be calculated in relation to the estimated inflow and to the flow rate of pump, to avoid an excessive number of starts for motor.
- Fix the pipes as not to damage the pump body by weight
- Make sure that the maximum suction depth does not exceed the level specified in the technical data of the product.

On the suction pipe will be installed mandatory a check valve in the end placed in the well to avoid intrusion of foreign particles

On the outlet pipe will be installed mandatory a non-return valve and a tap, in this order

- **Pump suction from the buffer tank**

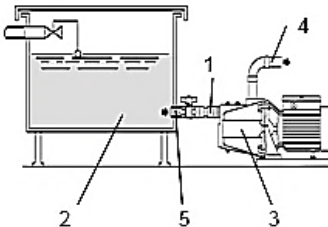

1. Backflow preventer
2. Buffer tank
3. Pump
4. Outlet pipe 1"
5. Inlet pipe 1"

- **Pump suction from the well (maxim height suction 8m):**

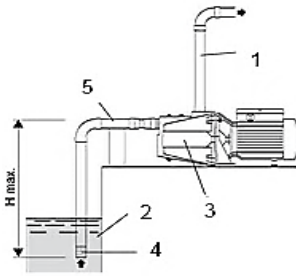

1. Outlet pipe 1"
2. Well
3. Pump
4. Suction
5. Inlet pipe1"

Starting the pump:



WARNING! DO NOT START THE PUMP WITHOUT WATER

- Through the out hole (7) pour in clean water in the suction pipe until the pump is fill with water.
- Tighten the outlet pipe.
- Plug the pump of the electrical network and press the ON/OFF switch (5) from the side panel.
- If the pump delivers water means you succeeded.
- If the pomp don't delivers water resume operations above.

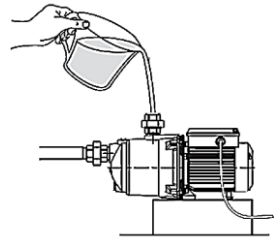

Electrical connection

- Is advisable to connect the pump to a dedicated grounded power line.
- These pumps with single-phase motor are provided with a built-in thermal overload protection and could be connected directly to the power grid through the power cord supplied (4)



Warning! If the motor is overloaded it stops automatically. Once it has cool down it starts again automatically without requiring any manual intervention.

Cleaning and maintenance



Before performing any work on the equipment, pull the power plug.

Cleaning

- Keep the ventilations slots of the machine clean to prevent overheating of the engine.
- Never use solvents such as petrol, alcohol, ammonia water, etc. These solvents may damage the plastic parts.

Maintenance

Our machines have been designed to operate over a long period of time with a minimum of maintenance. In normal operation the pump does not require any type of maintenance, thanks to the oil bath lubricated seal and to the grease-for-life bearings.

Grafic H-Q for Jet 105 -800 W

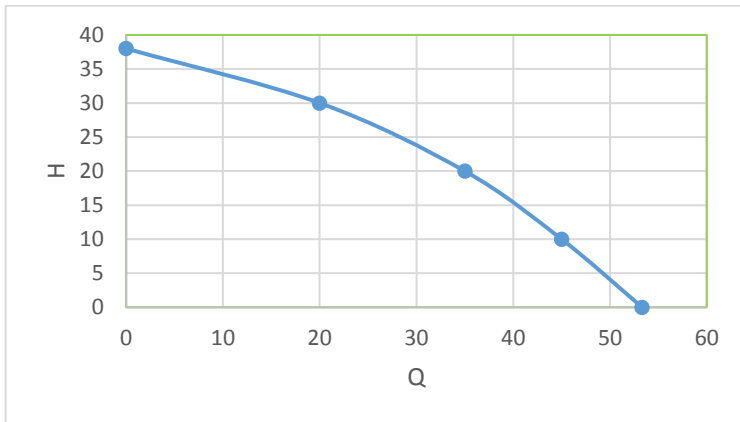

Technical data

Power	800W
Voltage / Frequency	230V/50Hz
Maximum flow	53 L/ min
Liquid temperature range	35°C
Maximum suction height	8m
Maximum height	38m
Connections Inlet/outlet	1 - 1"
Electric motor type	Forced ventilation
Pole numbers	2
Insulation class	F
Protection	IPX4
Working cycle	S1 - continuous
Overload protection	Autoreset thermal protection
Pump body material	Plastic
Shaft sealing	Mechanical seal
Bearing	Sealed ball bearing
Sound pressure level	LwA=90dB(A)
Weight	9.2 kg

Storage

- Store it out of the reach of children, in a stable and secure position, dust-free and avoid too high and too low temperatures.
- Protect it from exposure to direct sunlight. Keep it in the dark, if possible.